

2026

# MEDICAL PRODUCT RANGE

## PRICE LIST

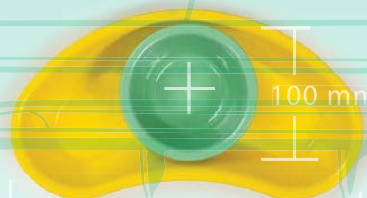
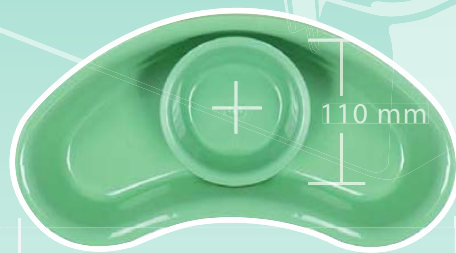

PP



**Douglas Bean**  
Australia



MEDICAL

CATERING

LABORATORY



# Douglas Bean Australia

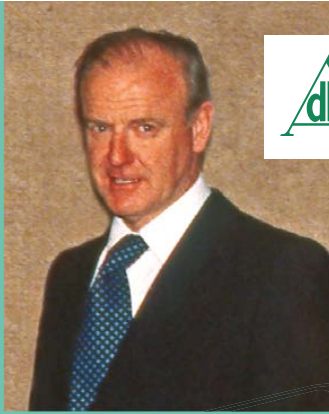

Douglas Bean c.1981



Douglas Bean began manufacturing plastic ware in the early 1960s, opening a factory in Richmond, Victoria.

Douglas Bean (Australia) has supplied durable, reliable, utilitarian products to Health and Aged Care Sectors for more than fifty years. Sons Nick and Richard are proud to continue the company's commitment to high quality products that are locally designed and manufactured.

Company Directors Nick and Richard Bean



## SUSTAINABILITY

All of our medical products are readily recyclable in Australia and New Zealand, with the exception of the small silicone inserts used in some of our perforated trays. All of our products are designed to last for many years, being made from durable, stable polypropylene. All trays, bowls, soaking trays, pans, storage trays and kidney dishes can be fully recycled at the end of their life.



# INTERNATIONAL MEDICAL PRODUCTS CONTENTS:



Medical BOWLS pp. 4-5

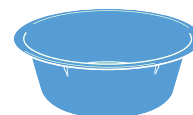

KIDNEY Dishes pp. 6-7



Bed PANS & Urinals pp. 8-9



Soaking TANKS pp. 10-13

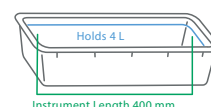

Medical TRAYS pp. 14-26

PROCEDURE & DRESSING TRAYS pp. 14-17



PERFORATED TRAYS pp. 17-20



STORAGE TRAYS/DENTURE BOXES pp. 20-21



INSTRUMENT CASSETTES pp. 22-24



DENTAL TRAYS & EQUIPMENT p. 24

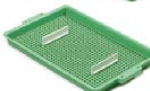

TRAYS LIST / ORDER FORM pp. 25-26



I.D. Pads, Forceps p. 27



Medical MEASURES p. 28



Company Information & Contact Details p. 29





# Douglas Bean Australia Medical Bowls

Our heavy duty, reusable medical bowls have been a staple for many hospitals and healthcare providers for over 30 years. They are suitable for surgical and general ward use. Designed and made in Australia from highly durable synthetic materials, all bowls have separator lugs for perfect autoclave sterilization.

Sizes



**345 mm**

Deep Splash Bowl

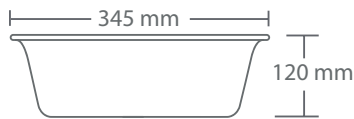

Pastel Green Mushroom



**305 mm**

Splash Bowl



Pastel Green Blue



**240 mm**

Lotion Bowl

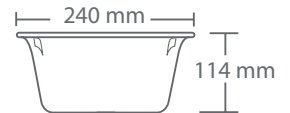

Pastel Green Blue

Colours

Codes

BWL34GR BWL34MU

BWL30GR BWL30BL

BWL24GR BWL24BL

Sizes



**210 mm**

Lotion Bowl



Pastel Green



**185 mm**

Lotion Bowl



Pastel Green Dusty Pink Grey



**140 mm**

Lotion Bowl



Pastel Green Blue Grey

Colours

Codes

BWL21GR

BWL18GR BWL18DP BWL18GY

BWL14GR BWL14BL BWL14GY

# Medical Bowls CONTINUED

• All bowls are TGA approved – ARTG 157301 • Suitable for surgical and general ward use



**110 mm**  
Lotion Bowl



Pastel Green

BWL11GR



**100 mm**  
Lotion Bowl

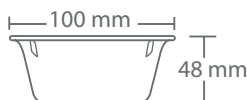

Pastel Green Blue

BWL10GR BWL10BL



**80 mm**  
Gallipot



Pastel Green

BWL08GR



**60 mm**  
Small Bowl

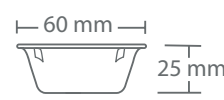

Pastel Green

BWL06GR

Sizes

Colours

Codes



110 mm bowl fits in  
300 mm kidney dish



100 mm bowl fits in  
255 mm kidney dish



80 mm bowl fits in  
220 mm kidney dish



60 mm bowl fits in  
160 mm kidney dish

Fits

## Medical Bowls Price List/ORDER FORM



✓	BOWL SIZE AND USE	COLOUR	CODES	Each	Price/10	Box Size	My Order Qty.
<input type="checkbox"/>	345 mm Bowl – Bedside Sponge -	Pastel Green	BWL34GR	\$28.00	\$215.00	10	<input type="text"/>
<input type="checkbox"/>	345 mm Bowl – Bedside Sponge -	Mushroom	BWL34MU	\$28.00	\$215.00	10	<input type="text"/>
<input type="checkbox"/>	305 mm Bowl – Bedside Splash -	Pastel Green	BWL30GR	\$20.80	\$160.00	20	<input type="text"/>
<input type="checkbox"/>	305 mm Bowl – Bedside Splash -	Blue	BWL30BL	\$20.80	\$160.00	20	<input type="text"/>
<input type="checkbox"/>	240 mm Bowl – Deep Lotion -	Pastel Green	BWL24GR	\$15.10	\$116.00	20	<input type="text"/>
<input type="checkbox"/>	240 mm Bowl – Deep Lotion -	Blue	BWL24BL	\$15.10	\$116.00	20	<input type="text"/>
<input type="checkbox"/>	210 mm Bowl – Shallow -	Pastel Green	BWL21GR	\$10.40	\$80.00	20	<input type="text"/>
<input type="checkbox"/>	185 mm Bowl – Lotion -	Pastel Green	BWL18GR	\$9.10	\$70.00	20	<input type="text"/>
<input type="checkbox"/>	185 mm Bowl – Lotion -	Dusty Pink	BWL18DP	\$9.10	\$70.00	20	<input type="text"/>
<input type="checkbox"/>	185 mm Bowl – Lotion -	Grey	BWL18GY	\$9.10	\$70.00	20	<input type="text"/>
<input type="checkbox"/>	140 mm Bowl – Lotion -	Pastel Green	BWL14GR	\$6.40	\$49.50	20	<input type="text"/>
<input type="checkbox"/>	140 mm Bowl – Lotion -	Blue	BWL14BL	\$6.40	\$49.50	20	<input type="text"/>
<input type="checkbox"/>	140 mm Bowl – Lotion -	Grey	BWL14GY	\$6.40	\$49.50	20	<input type="text"/>
<input type="checkbox"/>	110 mm Bowl – Lotion -	Pastel Green	BWL11GR	\$4.55	\$35.00	20	<input type="text"/>
<input type="checkbox"/>	100 mm Bowl – Lotion -	Pastel Green	BWL10GR	\$4.30	\$33.00	20	<input type="text"/>
<input type="checkbox"/>	100 mm Bowl – Lotion -	Blue	BWL10BL	\$4.30	\$33.00	20	<input type="text"/>
<input type="checkbox"/>	80 mm Bowl – Gallipot -	Pastel Green	BWL08GR	\$3.80	\$30.00	20	<input type="text"/>
<input type="checkbox"/>	60 mm Bowl – Small -	Pastel Green	BWL06GR	\$3.60	\$27.60	120	<input type="text"/>

Include Codes to specify colour. Prices exclude GST and freight. Fill in page and send a photo to order, or contact us by phone or email: [info@douglasbean.com.au](mailto:info@douglasbean.com.au) or call on (03) 9801 4400 or 1800 338 212 for orders or enquiries. You now can also request quotes online at [douglasbean.com.au](http://douglasbean.com.au)

[Back to Contents Page](#)

[douglasbean.com.au](http://douglasbean.com.au)



# Douglas Bean Australia Kidney Dishes

- All Kidney Dishes have TGA approval – ARTG 157299
- Heavy duty • Reusable • Suitable for surgical and general ward use
- Designed and made in Australia
- Separator lugs for perfect autoclave sterilization

## Sizes

**300 mm**  
Kidney Dish



Graduated each 200 to 800 ml

**255 mm**  
Kidney Dish

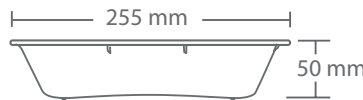

Graduated each 100 to 600 ml

**220 mm**  
Kidney Dish



Graduated each 100 to 400 ml

## Colours

Pastel Green

Blue

Yellow

Pastel Green

Blue

Yellow

Pastel Green

Blue

Yellow

## Codes

KD30GR

KD30BL

KD30YE

KD25GR

KD25BL

KD25YE

KD22GR

KD22BL

KD22YE

## Size

**160 mm**  
Kidney Dish



Graduated each 50 to 200 ml



Pastel Green



Blue



Yellow



## Kidney Dish & Bowl Sets



160 mm Kidney Dish  
fits 60 mm Bowl



220 mm Kidney Dish  
fits 80 mm Bowl



255 mm Kidney Dish  
fits 100 mm Bowl



300 mm Kidney Dish  
fits 110 mm Bowl

## Colour

## Code

KD16GR

KD16BL

KD16YE



**Douglas Bean**  
Australia

[Back to Contents Page](#)

M E D I C A L   E Q U I P M E N T

# Kidney Dishes

## PRICE LIST / ORDER FORM



• All Kidney Dishes are suitable for surgical and general ward use

✓	DISH SIZE	COLOUR	CODES	Each	Per 10	Box Quantity	My Order Quantity
<input type="checkbox"/>	300 mm Kidney Dish - Pastel Green		KD30GR	\$10.00	\$77.00		<input type="text"/>
<input type="checkbox"/>	300 mm Kidney Dish - Blue		KD30BL	\$10.00	\$77.00		<input type="text"/>
<input type="checkbox"/>	300 mm Kidney Dish - Yellow		KD30YE	\$10.00	\$77.00		<input type="text"/>
<input type="checkbox"/>	255 mm Kidney Dish - Pastel Green		KD25GR	\$8.60	\$66.00		<input type="text"/>
<input type="checkbox"/>	255 mm Kidney Dish - Blue		KD25BL	\$8.60	\$66.00		<input type="text"/>
<input type="checkbox"/>	255 mm Kidney Dish - Yellow		KD25YE	\$8.60	\$66.00		<input type="text"/>
<input type="checkbox"/>	220 mm Kidney Dish - Pastel Green		KD22GR	\$7.60	\$58.00		<input type="text"/>
<input type="checkbox"/>	220 mm Kidney Dish - Blue		KD22BL	\$7.60	\$58.00		<input type="text"/>
<input type="checkbox"/>	220 mm Kidney Dish - Yellow		KD22YE	\$7.60	\$58.00		<input type="text"/>
<input type="checkbox"/>	160 mm Kidney Dish - Pastel Green		KD16GR	\$6.50	\$49.90		<input type="text"/>
<input type="checkbox"/>	160 mm Kidney Dish - Blue		KD16BL	\$6.50	\$49.90		<input type="text"/>
<input type="checkbox"/>	160 mm Kidney Dish - Yellow		KD16YEL	\$6.50	\$49.90		<input type="text"/>

Prices do not include GST and freight. Include CODES to specify colour.

Fill in page and email an image to order, or contact us by email: [info@douglasbean.com.au](mailto:info@douglasbean.com.au)

or call on (03) 9801 4400 or 1800 338 212 for orders or enquiries.

You now can also request quotes online at [douglasbean.com.au](http://douglasbean.com.au)



# Douglas Bean

## Australia

MEDICAL

CATERING

LABORATORY

[Back to Contents Page](#)

[douglasbean.com.au](http://douglasbean.com.au)



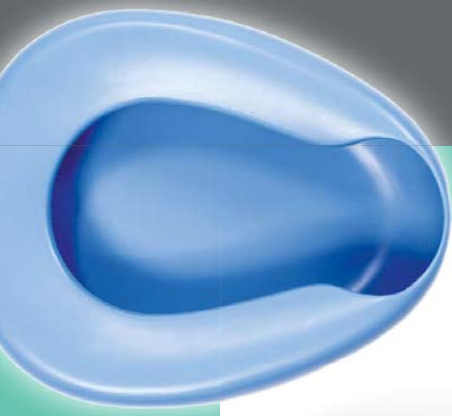

# Douglas Bean Australia Bed Pans & Urinals

Designed and made in Australia from high durability synthetic materials, all pans and urinals can be autoclaved.



Item

Autoplas Bedpan

Autoplas Bedpan Cover

Autoplas Slipper Pan

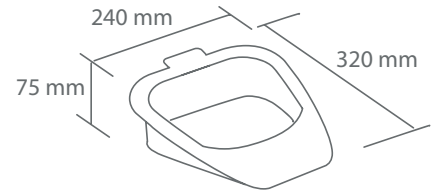
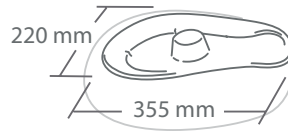
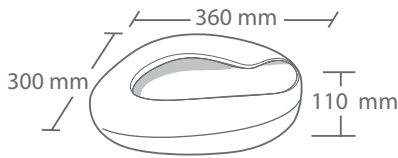

Colours

Pastel Green Blue

Mushroom Pastel Green

Pastel Green

Codes

PANBEGR

PANBEBL

PANBECOVMU

PANBECOVGR

PANSLGR

Item



Autoplas Slipper Pan

430 x 300 mm

Autoplas Commode  
Pan & Lid

- Handle for easy transfer

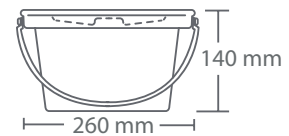

Colours

Pastel Green Mushroom

Mushroom

Codes

PANSL43X30GR

PANSL43X30MU

PANCORDMU



**Douglas Bean**  
Australia

[Back to Contents Page](#)

# Bed Pans & Urinals CONTINUED



## Autoplas Specimen Pan



- to collect urine specimens
- 1 litre, graduated
- fits under any toilet seat
- stackable, with pouring spout

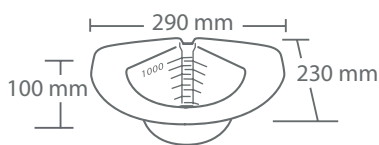

○ Natural    ● Mushroom

PANSPNA    PANSPMU

## Autoplas Male Urinal



- easy to read graduations
- strong handle, stands on base

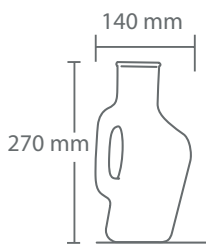

● Pastel Green    ○ Natural

URLMAGR    URLMANA

## Bedside Urinal Holder

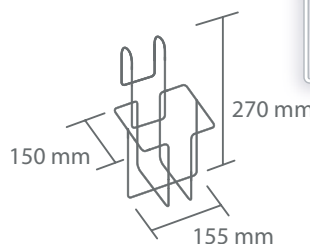

○ White

UBHHOOK

Items

Colours

Codes

# Bedpans & Urinals PRICE LIST/ORDER FORM



✓	Bedpans & Urinals	CODES	COLOURS	Each	Price/10	Box Size	My Order Qty.
<input type="checkbox"/>	Bedpan	● PANBGR	PASTEL GREEN	\$63.00	\$500.00	5	<input type="text"/>
<input type="checkbox"/>	Bedpan	● PANBEBL	BLUE	\$63.00	\$500.00	5	<input type="text"/>
<input type="checkbox"/>	Bedpan Cover	● PANBECOVGR	PASTEL GREEN	\$15.50	\$118.00	10	<input type="text"/>
<input type="checkbox"/>	Bedpan Cover	● PANBECVMU	MUSHROOM	\$15.50	\$118.00	10	<input type="text"/>
<input type="checkbox"/>	Slipper Pan 320 mm x 240 mm	● PANSLGR	PASTEL GREEN	\$26.00	\$200.00	10	<input type="text"/>
<input type="checkbox"/>	Slipper Pan 430 mm x 300 mm	● PANSL43X30GR	PASTEL GREEN	\$40.95	\$315.00	10	<input type="text"/>
<input type="checkbox"/>	Slipper Pan 430 mm x 300 mm	● PANSL43X30MU	MUSHROOM	\$40.95	\$315.00	10	<input type="text"/>
<input type="checkbox"/>	Commode Pan & Lid (round)	● PANCORDMU	MUSHROOM	\$26.00	\$200.00	10	<input type="text"/>
<input type="checkbox"/>	Specimen Pan	○ PANSPNA	NATURAL	\$16.50	\$126.00	10	<input type="text"/>
<input type="checkbox"/>	Specimen Pan	● PANSPMU	MUSHROOM	\$16.50	\$126.00	10	<input type="text"/>
<input type="checkbox"/>	Urinal	● URLMAGR	PASTEL GREEN	\$15.25	\$105.00	10	<input type="text"/>
<input type="checkbox"/>	Urinal	○ URLMANA	NATURAL	\$15.25	\$105.00	10	<input type="text"/>
<input type="checkbox"/>	Bedside Urinal Holder (hooked)	○ UBHHOOK	WHITE	\$45.50	\$360.00	2	<input type="text"/>

Prices above do not include GST and freight. Include CODES to specify colour. Fill in page and email an image to order, or contact us: [info@douglasbean.com.au](mailto:info@douglasbean.com.au) or call on (03) 9801 4400 or 1800 338 212 for orders or enquiries. You can also request quotations at [douglasbean.com.au](http://douglasbean.com.au)



**Douglas Bean**  
Australia

[douglasbean.com.au](http://douglasbean.com.au)

MEDICAL

CATERING

LABORATORY

p. 9

[Back to Contents Page](#)

# Douglas Bean Australia Soaking Tanks

- All tanks are TGA approved – ARTG 157299
- Heavy duty
- Reusable
- Separator lugs for perfect autoclave sterilization

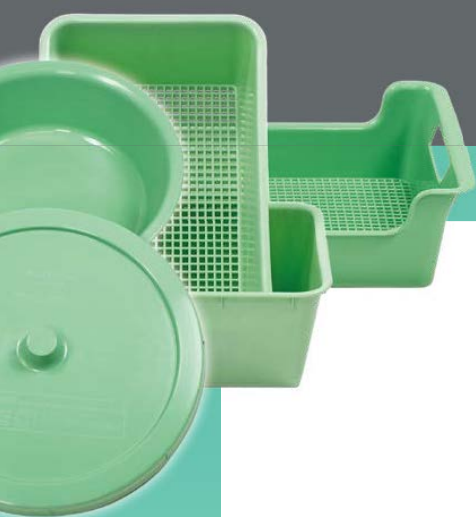

Size

Soaking Tank & Lid for Instrument Length 850 mm

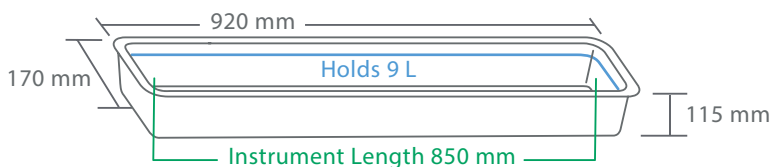

Code

TRS850GR ● Pastel Green only

SOAKING TANK RANGE

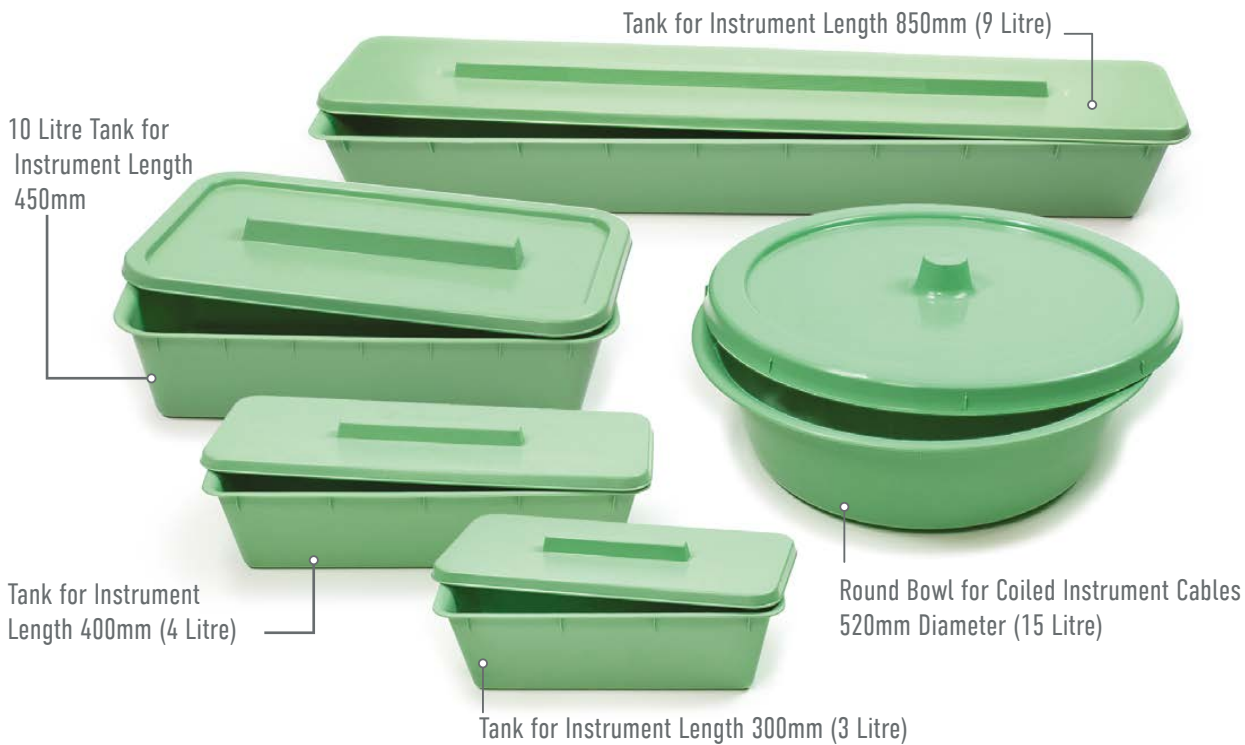

SOAKING TANK RANGE



**Douglas Bean**  
Australia

[Back to Contents Page](#)

# Soaking Tanks CONTINUED



## Soaking Tank & Lid for Instrument Length 400mm (4 L)

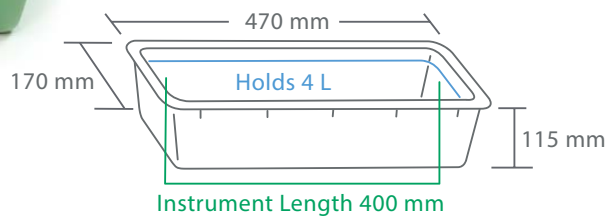

Size

TRS400GR ● Pastel Green only

Code

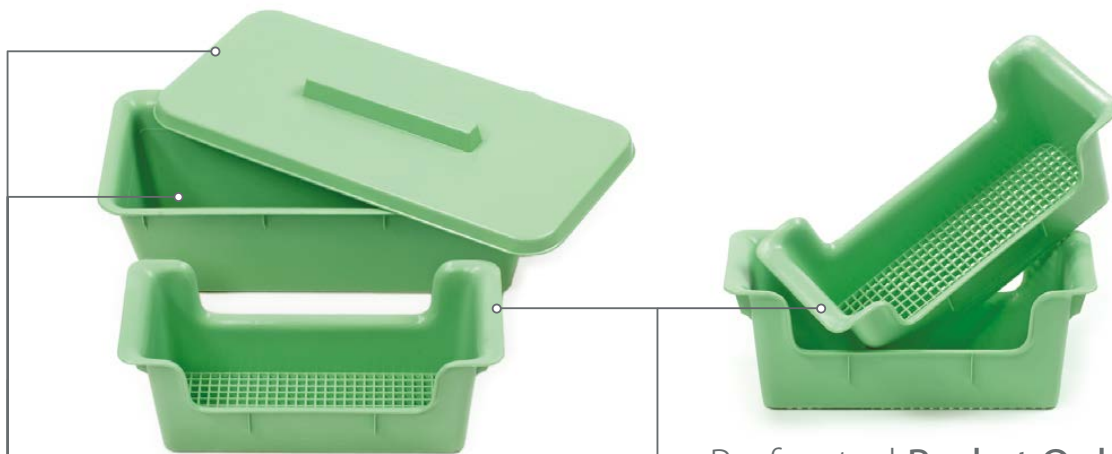

## Soaking Tank & Lid for Instrument Length 300mm (3 L) Basket not included

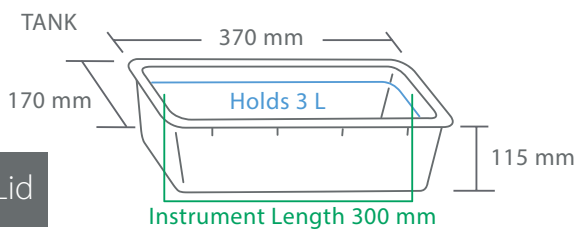

## Perforated Basket Only for 300 mm (3 L) Tank shown left

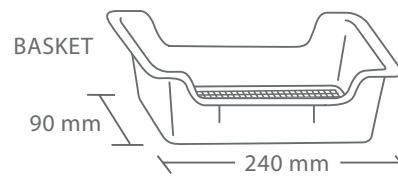

Item

Tank & Lid

Basket Only

TRS300GR ● Pastel Green only

TRSB300GR ● Pastel Green only

Codes

# Soaking Tanks CONTINUED

- All tanks are TGA approved
- Heavy duty
- Reusable
- ARTG 157299
- Separator lugs for perfect autoclave sterilization



**Soaking Tank & Lid** for Instrument Length **450 mm (10 L)**  
(basket not included)

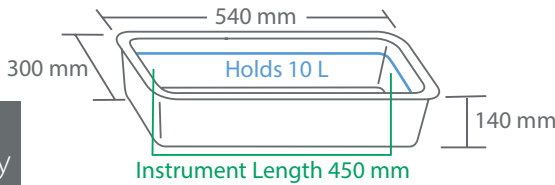

Lid Only

Tank & Lid Set

Tank Only

Codes

TR554X30LIDGR



All Pastel Green

TR554X30LIDGR  
TR554X30BWLGR

TR554X30BWLGR

Sizes

**440 mm Soaking Tank Basket Only**  
for Instrument Length **450 mm**  
(fits inside 10 L Soaking Tank, shown above)

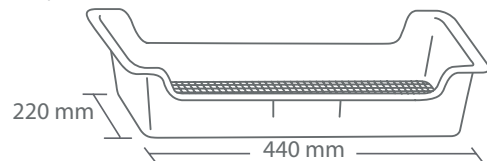

Basket Only

Codes

TR5B500GR



Pastel Green

# Soaking Tanks CONTINUED



Soaking Bowl & Lid  
for coiled instrument cables  
**500mm Diameter**

Size

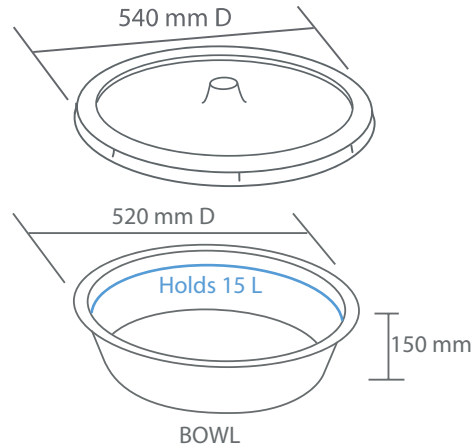

Lid Only

Bowl Only

TRSBWL52LIDGR

All Pastel Green

TRSBWL52GR

Codes

## SOAKING TANKS PRICE LIST/ORDER FORM



✓ Soaking Tanks	Colour	CODE	Price	Price/10	Box Size	My Order Qty.
X2 <input type="checkbox"/> 850mm Soaking Tank - 2 x TANKS & 2 x LIDS		TRS850GR	\$142.00 per pair	\$710.00	2	<input type="text"/>
X2 <input type="checkbox"/> Matching LIDS for below 10 L. Tank (price for 2)		TRS54X30LIDGR	\$156.00 per pair	\$780.00	2	<input type="text"/>
X2 <input type="checkbox"/> 10 L. TANK for instrumt. length 450 mm (price for 2)		TRS54X30BWLGR				
<input type="checkbox"/> For 450 mm length instrmts. (10 L) - BASKET ONLY		TRSB500GR	\$44.80	\$320.00	10	<input type="text"/>
X2 <input type="checkbox"/> 400 mm Soaking Tank (4 L) - 2 x TANKS & 2 x LIDS		TRS400GR	\$90.00 per pair	\$450.00	2	<input type="text"/>
X2 <input type="checkbox"/> 300 mm Soaking Tank (3 L) - 2 x TANKS & 2 x LIDS		TRS300GR	\$65.00 per pair	\$325.00	2	<input type="text"/>
<input type="checkbox"/> For 300 mm Soaking Tank - BASKET ONLY		TRSB300GR	\$17.50	\$132.00	2	<input type="text"/>
X2 <input type="checkbox"/> 520 mm D. Soaking Bowl (15 L) - 2 x BOWLS ONLY		TRSBWL52GR	\$87.00 per pair	\$435.00	2	<input type="text"/>
X2 <input type="checkbox"/> 520 mm D. Soaking Bowl (15 L) - 2 x LIDS ONLY		TRSBWL52LIDGR	\$70.00 per pair	\$350.00	2	<input type="text"/>

Prices above exclude GST and freight. Fill in page and email an image to us, or contact us by email: [info@douglasbean.com.au](mailto:info@douglasbean.com.au) or call on (03) 9801 4400 or 1800 338 212 for orders and enquiries.

You can also request quotations online: [douglasbean.com.au](http://douglasbean.com.au)

[Back to Contents Page](#)

[douglasbean.com.au](http://douglasbean.com.au)





# MEDICAL TRAYS RANGE

## Procedure & Dressing Trays

- All trays are TGA approved – ARTG 157299
- Heavy duty
- Reusable
- Suitable for surgical and general ward use.
- Separator lugs for perfect autoclave sterilization

Sizes



270 x 100 x 40 mm  
Injection Tray



200 x 75 x 30 mm  
Injection Tray



Colours



Pastel Green



Yellow



Blue



Pastel Green



Yellow



Blue

Codes

TRINJ270GR

TRINJ270YE

TRINJ270BL

TRINJ200GR

TRINJ200YE

TRINJ200BL

Sizes



205 x 165 mm  
3 Compartment Tray

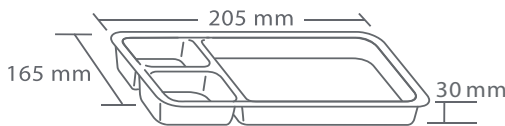

160 x 140 mm  
3 Compartment Tray

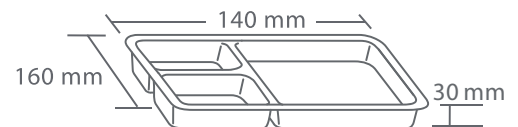

Colours



Pastel Green



Blue



Natural



Pastel Green only

Codes

TRD3C20X16GR

TRD3C20X16BL

TRD3C20X16NA

TRD3C16X14GR

# Procedure & Dressing Trays



**300 x 270 x 50 mm**  
Flat instrument Tray



Pastel Green      Blue      Yellow

TRD30X27GR    TRD30X27BL    TRD30X27YE



**Lid to fit 270 x 150 mm** Instrument Trays



**270 x 150 x 40 mm** Flat instrument Tray

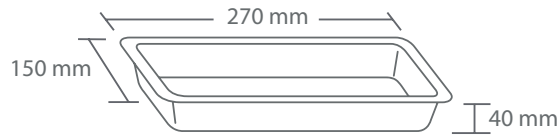

Pastel Green      Blue      LIDS in Pastel Green or Blue

TRD27X15GR    TRD27X15BL    TRD27X15LIDGR    TRD27X15LIDBL

Sizes

Sizes

Colours

Codes



**245 x 195 x 45 mm**  
Flat instrument Tray



Pastel Green      Blue      Yellow

TRD24X19GR    TRD24X19BL    TRD24X19YE



**220 x 140 x 20 mm**  
Flat instrument Tray

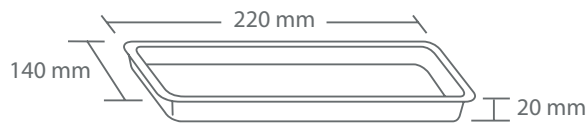

Pastel Green      Yellow      Natural

TRD22X14GR    TRD22X14YE    TRD22X14NA

Sizes

Colours

Codes

# Procedure & Dressing Trays CONTD.

Size



**270 x 150 mm** 3 Compartment Tray  
(fits Lids TRD27X15LIDGR/BL)

Size

**270 x 205 mm**  
4 Compartment Tray

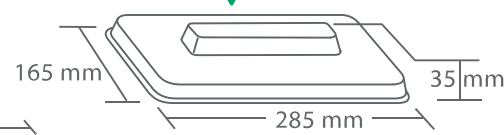
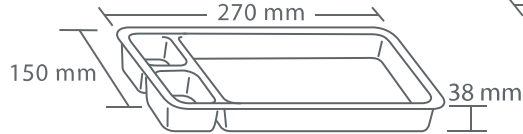
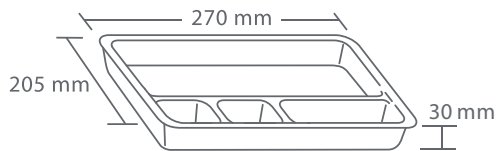

Colours



Pastel Green



Dusty Pink



Pastel Green



Blue



Matching LIDS in Pastel Green or Blue

Codes

TRD4C27X20GR

TRD3C27X15DP

TRD3C27X15GR

TRD3C27X15BL

TRD27X15LIDGR

TRD27X15LIDBL

PERFORATED TRAYS

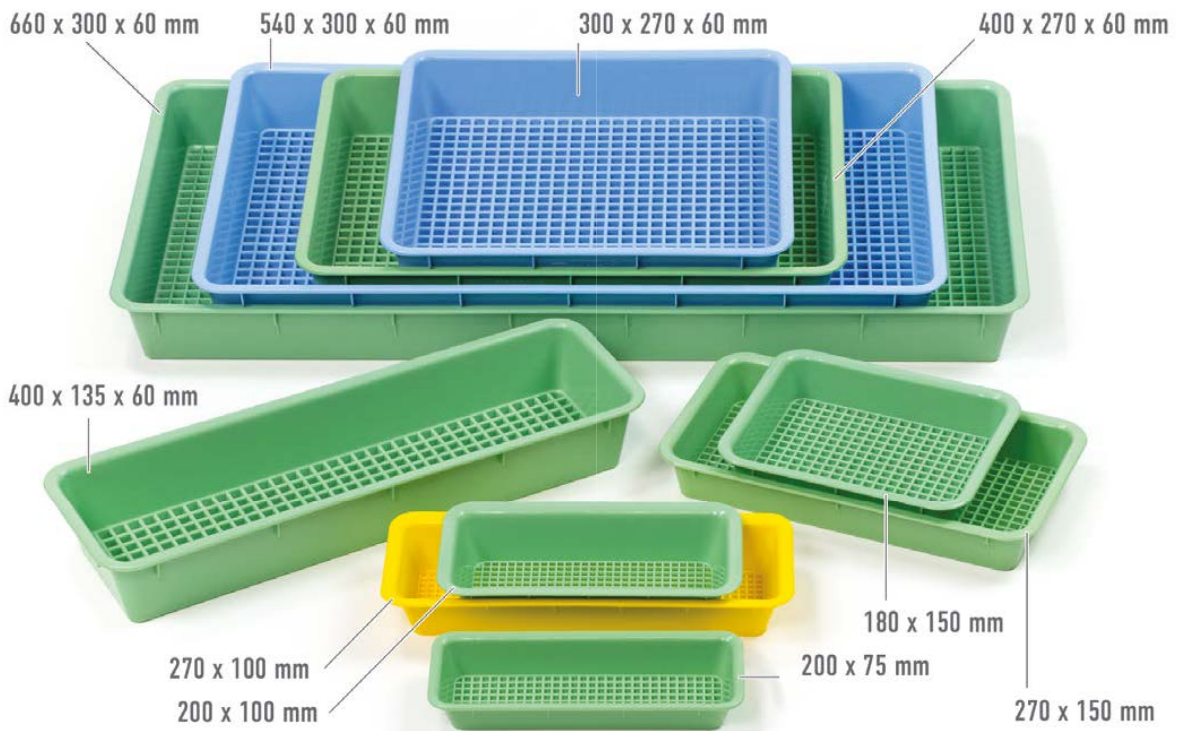

## PERFORATED SURGICAL TRAY RANGE

# Perforated Trays

- All trays are TGA approved – ARTG 157299
- Heavy duty • Reusable
- Suitable for surgical use
- Separator lugs for perfect autoclave sterilization

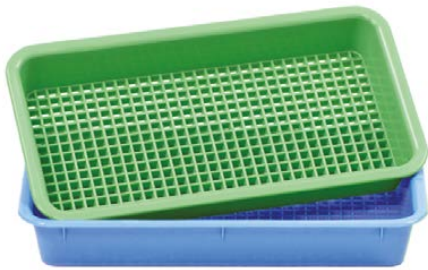

270 x 150 x 38 mm  
Perforated Tray

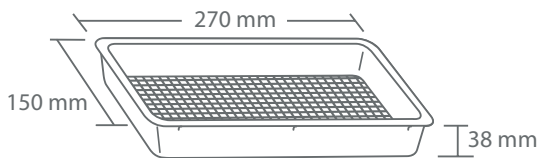

TRP27X15GR

TRP27X15BL



300 x 270 x 60 mm  
Perforated Tray

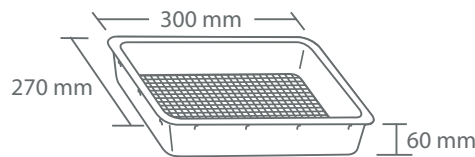

TRP30X27GR

TRP30X27BL

Sizes

Colours

Codes



270 x 100 x 40 mm  
Perforated Tray

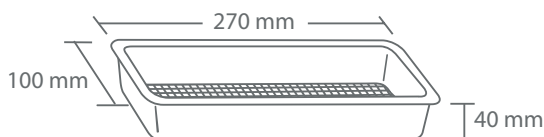

TRP27X10GR

TRP27X10YE



200 x 100 x 40 mm  
Perforated Tray

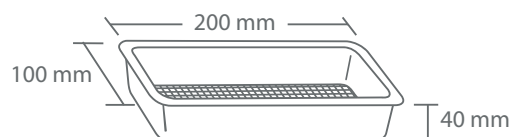

TRP20X10GR

Sizes

Colours

Codes

[Back to Contents Page](#)

[douglasbean.com.au](http://douglasbean.com.au)



# Perforated Trays CONTINUED

• All Perforated Trays are TGA approved – ARTG 157299

Sizes

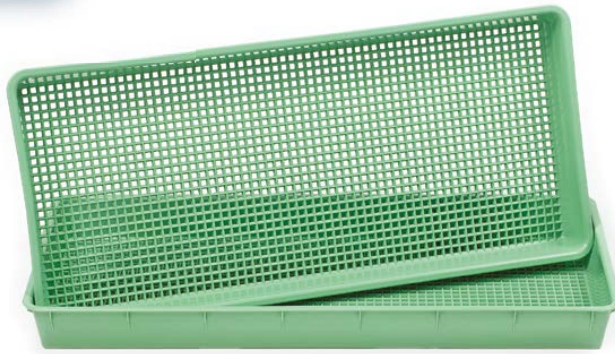

660 x 300 x 60 mm  
Perforated Tray

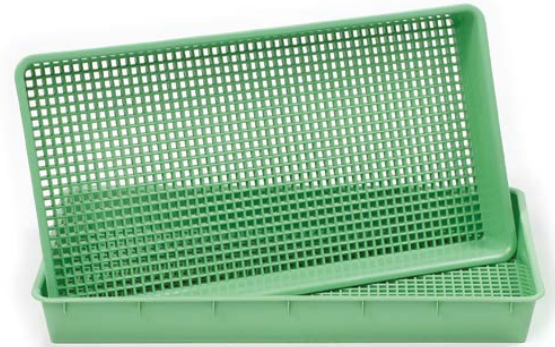
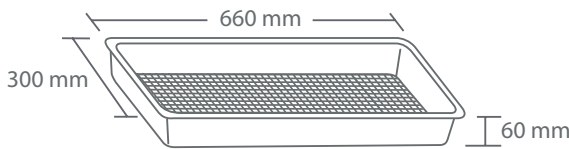

540 x 300 x 60 mm  
Perforated Tray

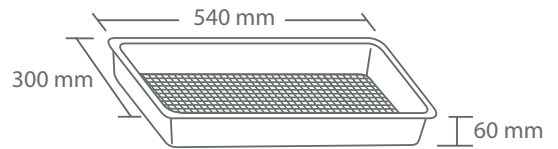

Colours

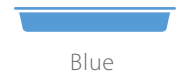

Codes

TRP66X30GR

TRP54X30GR

TRP54X30BL

Sizes



400 x 270 x 60 mm  
Perforated Tray

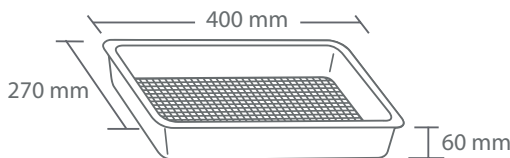

400 x 135 x 60 mm  
Perforated Tray

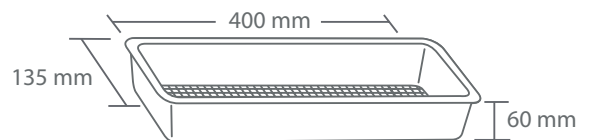

Colours



Codes

TRP40X27GR

TRP40X27BL

TRP40X13GR



**Douglas Bean**  
Australia

[Back to Contents Page](#)

# Perforated Trays CONTINUED



**200 x 75 x 30 mm**  
Perforated Tray

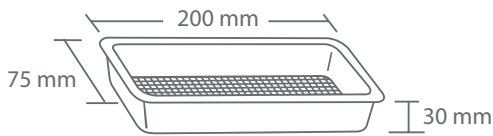

Pastel Green      Yellow

● TRP20X7GR      TRP20X7YE ●



**Perforated Instrument Basket**  
( fits inside 500 mm/10 L Soaking Tank )

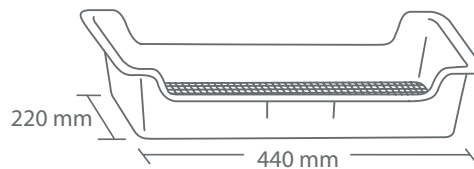

Pastel Green only

● TRSB500GR

Sizes

Colours

Codes



**180 x 150 x 30 mm**  
Perforated Tray

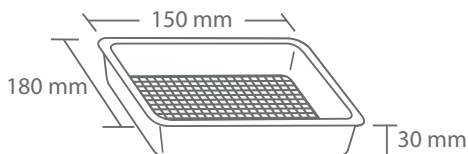

Pastel Green only

TRP18X15GR



**Perforated Deep Basket**

Suitable to hold dressing and compartment tray packs for autoclaving

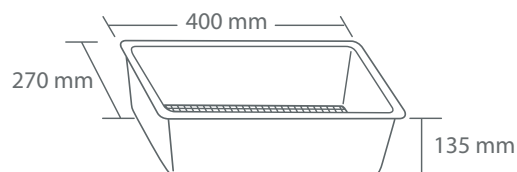

Pastel Green only ● TRPB40X27GR

Sizes

Codes

# Perforated Trays/Storage Trays

Size

**240 x 90 mm Perforated Basket**  
(to fit inside 300 mm Soaking Tank)

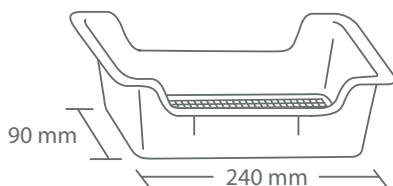

Code

Pastel Green only  TRSB300GR

## STORAGE TRAY RANGE

- Heavy duty • Reusable • Stackable
- Suitable for Autoclaving
- Boxes available in 6 colours

Size

**55 x 40 x 13 cm Stackable Tote Box Only**  
available in six colours

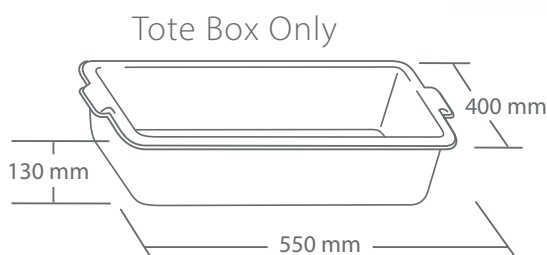

Box only



Colours



Pastel Green



Mushroom



Blue



Grey



Yellow



Orange

Codes



TOTEGR



TOTEMU



TOTEBL



TOTEGY



TOTEYE



TOTEOR



**Douglas Bean**  
Australia

[Back to Contents Page](#)

# Storage Trays CONTINUED



Lid only

**55 x 40 cm**  
Stackable Tote Box  
Lid Only

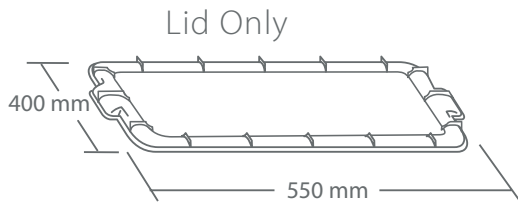

TOTELIDMU Lid available in Mushroom only



**Autoplas Rectangular**  
340 mm Storage Tray & Lid  
(Storage volume 280 x 210 x 95mm)

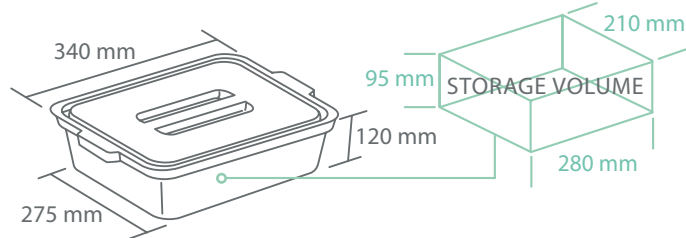

Pastel Green Mushroom

TRSL34X27GR TRSL34X27MU

Sizes

Colours

Codes



**Autoplas Denture Box & Lid**  
available in two colours.  
Patient details may be written on both  
box and lid. Both box and lid can be  
stacked to save space.

Item

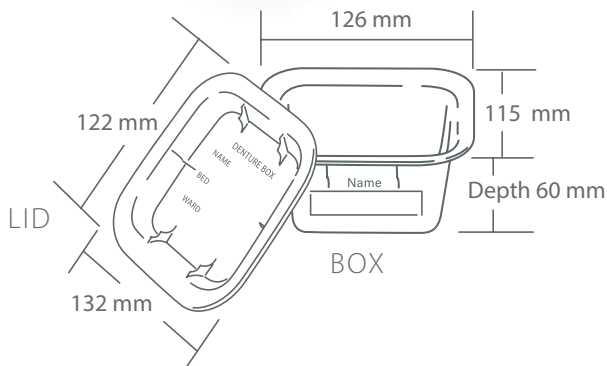

Pastel Green BOX & LID Pastel Green LID only



Blue BOX & LID

Colours

DENBOXGR DENBOXLIDGR

DENBOXBL

Codes

# Instrument Cassettes

Size

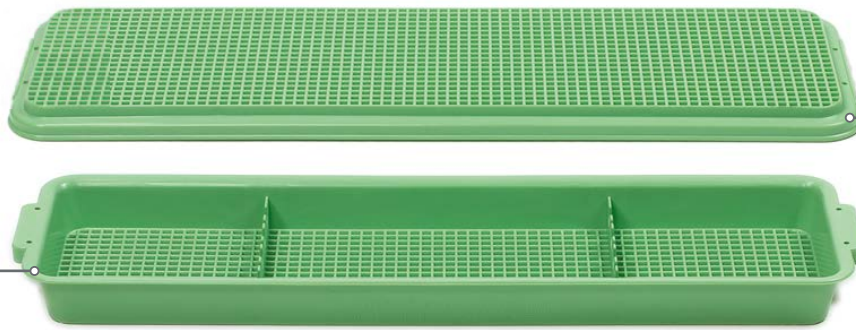

**540 x 160 x 40 mm Instrument Cassette**  
Tray and Lid sold separately



Tray includes molded racks

Tray

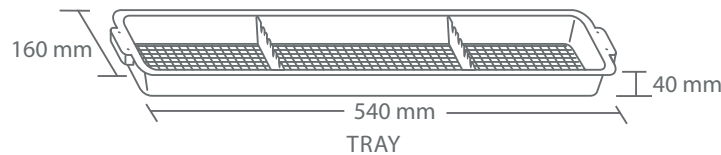

Lid

Codes

IC54X16TRGR

Lid & Base available in Pastel Green only

IC54X16LIDGR

Sizes

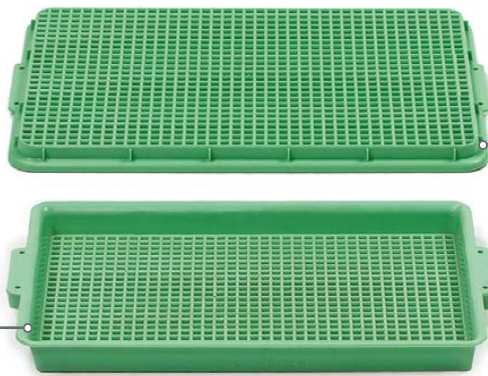

**Instrument Cassette**  
**300 x 205 x 30 mm**  
Tray and Lid sold separately

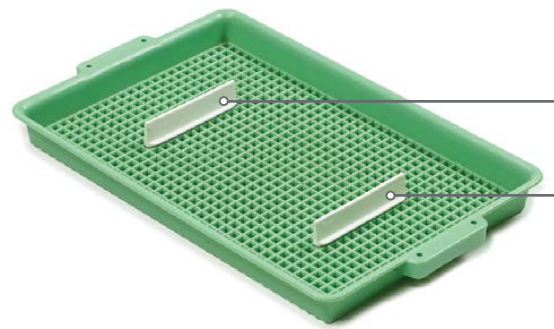

**Silicone Racks Only**  
to fit 300 x 205 x 30 mm  
Instrument Cassette  
**Set of 2 Racks**

Tray

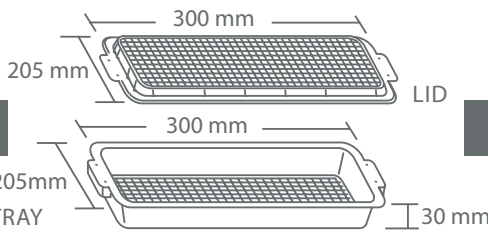

Lid

Racks



Silicone Racks available in white only

Colours

Codes

IC30X20TRGR

IC30X20LIDGR

IC30X20RAKWH

# Instrument Cassettes CONTD.

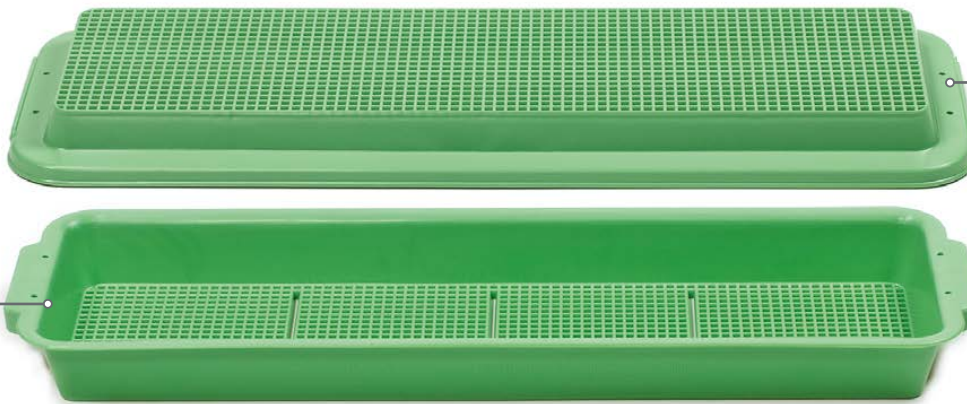

**540 x 180 x 50 mm**

Instrument Cassette Tray & Lid sold separately

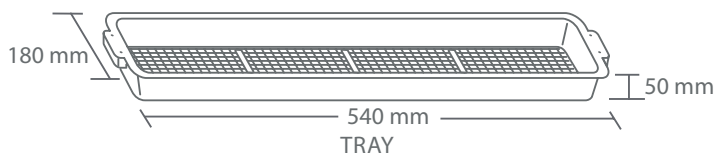

Tray

Lid

Size

IC54X18TRGR

Lid & Tray available in Pastel Green only

IC54X18LIDGR

Codes

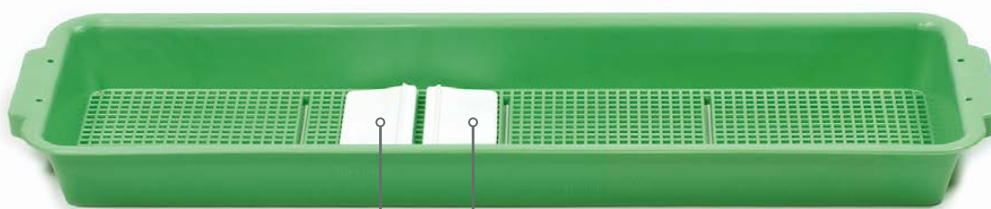

**Silicone Racks Only**

To fit 540 x 180 x 50 mm Instrument Cassette

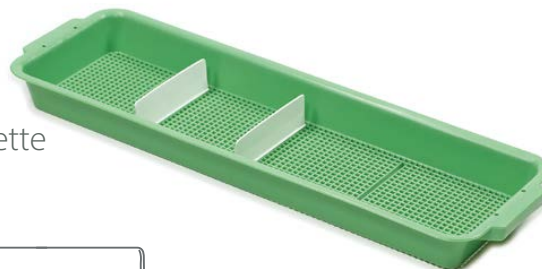

Racks

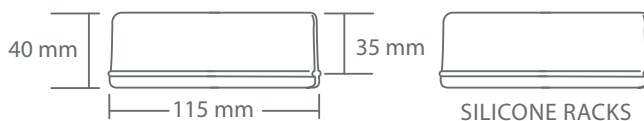

SILICONE RACKS

Fits

IC54X18RAKWH

Silicone Racks available in white only

Code

[Back to Contents Page](#)

[douglasbean.com.au](http://douglasbean.com.au)



# Instrument Cassettes CONTD.

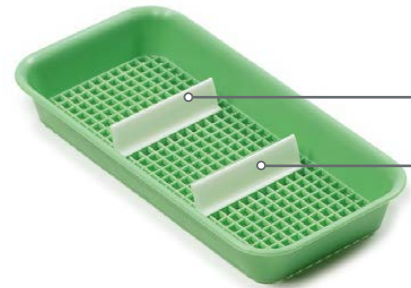
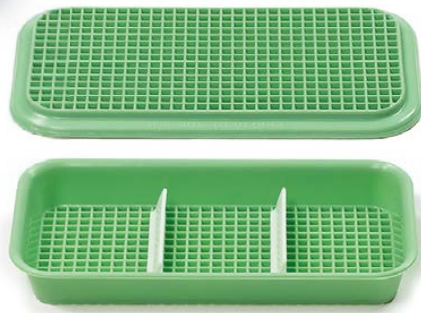
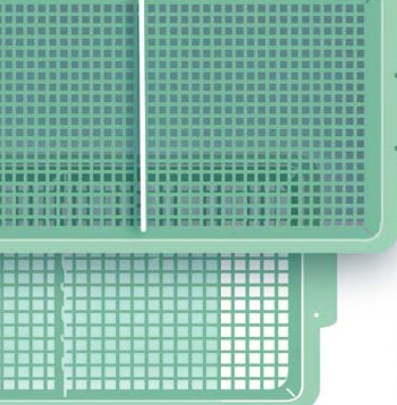

Sizes

**180 x 90 x 20 mm Instrument Cassette**  
Tray and Lid sold together, Racks included

**Silicone Racks Only**  
to fit 180 x 90 x 20 mm  
Instrument Cassette  
Set of 2 Racks

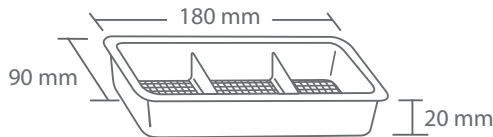

TRAY

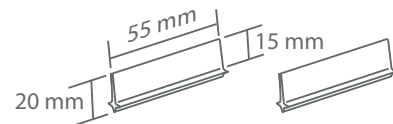

2 x SILICONE RACKS

Racks

Codes

IC18X9GR  Cassette Tray and Lid in Pastel Green.

IC18X9RAKWH  Racks in white only

Sizes

**90 x 90 x 20 mm Instrument Cassette**  
Tray and Lid sold together

**300 x 205 x 30 mm**  
Perforated Dental Tray

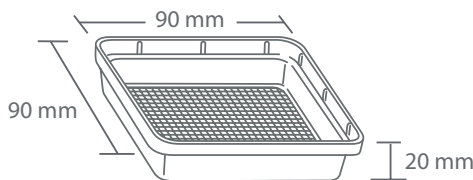

TRAY

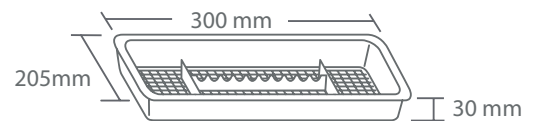

TRAY

Colour

Lid & Tray available in Pastel Green only

Tray available in Pastel Green only

Codes

IC09X09GR 

TRPD20X30GR 



**Douglas Bean**  
Australia

[Back to Contents Page](#)



# TRAYS PRICE LIST/ORDER FORM p.1

✓ Injection Trays		Codes & Colours	Each	Per 10	BOX	My Order
	200 x 75 x 30 mm Injection - Unperforated	TRINJ200GR	\$6.90	\$53.00	20	<input type="text"/>
	200 x 75 x 30 mm Injection - Unperforated	TRINJ200YE	\$6.90	\$53.00	20	<input type="text"/>
	200 x 75 x 30 mm Injection - Unperforated	TRINJ200BL	\$6.90	\$53.00	20	<input type="text"/>
	270 x 100 x 40 mm Injection - Unperforated	TRINJ270GR	\$10.40	\$80.00	20	<input type="text"/>
	270 x 100 x 40 mm Injection - Unperforated	TRINJ270YE	\$10.40	\$80.00	20	<input type="text"/>
	270 x 100 x 40 mm Injection - Unperforated	TRINJ270BL	\$10.40	\$80.00	20	<input type="text"/>
✓ Surgical Dressing Trays - Non Perforated		Codes & Colours	Each	Per 10	BOX	My Order
	220 x 140 x 20 mm Flat Instrument - Unperforated	TRD22X14GR	\$8.95	\$65.00	10	<input type="text"/>
	220 x 140 x 20 mm Flat Instrument - Unperforated	TRD22X14YE	\$8.95	\$65.00	10	<input type="text"/>
	220 x 140 x 20 mm Flat Instrument - Unperforated	TRD22X14NA	\$8.95	\$65.00	10	<input type="text"/>
	245 x 195 x 45 mm Flat Instrument - Unperforated	TRD24X19GR	\$12.35	\$95.00	10	<input type="text"/>
	245 x 195 x 45 mm Flat Instrument - Unperforated	TRD24X19YE	\$12.35	\$95.00	10	<input type="text"/>
	245 x 195 x 45 mm Flat Instrument - Unperforated	TRD24X19BL	\$12.35	\$95.00	10	<input type="text"/>
	270 x 150 x 40 mm Flat Instrument - Unperforated	TRD27X15GR	\$12.00	\$93.00	10	<input type="text"/>
	270 x 150 x 40 mm Flat Instrument - Unperforated	TRD27X15BL	\$12.00	\$93.00	10	<input type="text"/>
	Green LID to fit TRD27X15GR/BL, TRD3C27X15DP/GR	TRD27X15LIDGR	\$12.50	\$95.00	10	<input type="text"/>
	Blue LID to fit TRD27X15GR/BL, TRD3C27X15DP/GR	TRD27X15LIDBL	\$12.50	\$95.00	10	<input type="text"/>
	300 x 270 x 50 mm Flat Instrument - Unperforated	TRD30X27GR	\$18.90	\$147.00	10	<input type="text"/>
	300 x 270 x 50 mm Flat Instrument - Unperforated	TRD30X27BL	\$18.90	\$147.00	10	<input type="text"/>
	300 x 270 x 50 mm Flat Instrument - Unperforated	TRD30X27YE	\$18.90	\$147.00	10	<input type="text"/>
✓ Surgical Dressing Trays w/ Compartments		Codes & Colours	Each	Per 10	BOX	My Order
	3 Compartment 160 x 140 - Unperforated	TRD3C16X14GR	\$6.50	\$49.00	50	<input type="text"/>
	3 Compartment 205 x 165 - Unperforated	TRD3C20X16GR	\$8.95	\$66.00	10	<input type="text"/>
	3 Compartment 205 x 165 - Unperforated	TRD3C20X16BL	\$8.95	\$66.00	10	<input type="text"/>
	3 Compartment 205 x 165 - Unperforated	TRD3C20X16NA	\$8.95	\$66.00	10	<input type="text"/>
	3 Compartment 270 x 150 - Unperforated	TRD3C27X15GR	\$9.20	\$70.00	20	<input type="text"/>
	3 Compartment 270 x 150 - Unperforated	TRD3C27X15DP	\$9.20	\$70.00	20	<input type="text"/>
	4 Compartment 270 x 205 - Unperforated	TRD4C27X20GR	\$14.70	\$112.50	10	<input type="text"/>
✓ Surgical Dressing Trays - Perforated		Codes & Colours	Each	Per 10	BOX	My Order
	180 x 150 x 30 mm Perforated - Surgical Instrumt.	TRP18X15GR	\$9.10	\$70.00	10	<input type="text"/>
	200 x 75 x 30 mm Perforated - Surgical Instrumt.	TRP20X7GR	\$9.10	\$70.00	20	<input type="text"/>
	200 x 75 x 30 mm Perforated - Surgical Instrumt.	TRP20X7YE	\$9.10	\$70.00	20	<input type="text"/>
	200 x 100 x 40 mm Perforated - Surgical Instrumt.	TRP20X10GR	\$9.40	\$72.00	20	<input type="text"/>
	270 x 100 x 40 mm Perforated - Surgical Instrumt.	TRP27X10GR	\$9.90	\$76.00	20	<input type="text"/>
	270 x 100 x 40 mm Perforated - Surgical Instrumt.	TRP27X10YE	\$9.90	\$76.00	20	<input type="text"/>
	270 x 150 x 38 mm Perforated - Surgical Instrumt.	TRP27X15GR	\$12.75	\$91.00	10	<input type="text"/>
	270 x 150 x 38 mm Perforated - Surgical Instrumt.	TRP27X15BL	\$12.75	\$91.00	10	<input type="text"/>
	300 x 270 x 60 mm Perforated - Surgical Instrumt.	TRP30X27GR	\$30.00	\$215.00	10	<input type="text"/>
	300 x 270 x 60 mm Perforated - Surgical Instrumt.	TRP30X27BL	\$30.00	\$215.00	10	<input type="text"/>
	400 x 135 x 60 mm Perforated - Surgical Instrumt.	TRP40X13GR	\$34.00	\$240.00	10	<input type="text"/>



Price List continues next page. Prices exclude GST and freight.



# TRAYS PRICE LIST/ORDER FORM p.2

## ✓ Surgical Instrument Trays - Perf. (Contd.)

### CODES & Colours

Each Per 10 Box QTY. My Order

<input type="checkbox"/>	400 x 270 x 60 mm Perforated - Surgical Instrmt.	TRP40X27GR	●	\$42.00	\$315.00	10	
<input type="checkbox"/>	400 x 270 x 60 mm Perforated - Surgical Instrmt.	TRP40X27BL	●	\$42.00	\$315.00	10	
<input type="checkbox"/>	540 x 300 x 60 mm Perforated - Surgical Instrmt.	TRP54X30GR	●	\$49.00	\$370.00	10	
<input type="checkbox"/>	540 x 300 x 60 mm Perforated - Surgical Instrmt.	TRP54X30BL	●	\$49.00	\$370.00	10	
<input type="checkbox"/>	660 x 300 x 60 mm Perforated - Surgical Instrmt.	TRP66X30GR	●	\$63.65	\$480.00	2	
<input type="checkbox"/>	500 x 250 mm (10 L) Perf. Basket - Instrmt. Soak.	TRSB500GR	●	\$44.80	\$320.00	10	
<input type="checkbox"/>	400 x 270 x 135 mm (4 L) Perf. Bskt - Instrmt. Soak.	TRPB40X27GR	●	\$57.50	\$460.00	10	
<input type="checkbox"/>	240 x 90 mm Perf. Basket for 300mm tank (3 L)	TRSB300GR	●	\$17.50	\$132.00	10	



## ✓ Storage Trays

### CODES & Colours

Each Per 10 Box My Order

<input type="checkbox"/>	340 x 275 x 120 mm Storage Tray & Lid	TRSL34X27GR	●	\$27.70	\$205.00	10	
<input type="checkbox"/>	340 x 275 x 120 mm Storage Tray & Lid	TRSL34X27MU	●	\$27.70	\$205.00	10	
<input type="checkbox"/>	550 x 400 x 130 mm Tote Box Only, 6 Cols:	TOTEGR ● TOTEMU ● TOTEOR ●		\$41.60	\$320.00	5	
	Pastel Green, Mushroom, Orange, Grey, Blue, Yellow	TOTEGY ● TOTEBL ● TOTEYE ●		\$41.60	\$320.00		
<input type="checkbox"/>	Lid only - fits 550 x 400 x 130 mm Tote Box	TOTELIDMU ●		\$26.00	\$195.00	5	
<input type="checkbox"/>	AUTOPLAS Denture Box & Lid - Pastel Green or Blue	DENBOXGR ● DENBOXBL ●		\$6.45	\$46.00	20	
<input type="checkbox"/>	AUTOPLAS Dent. Box Lid Only - Pastel Green	DENBOXLIDGR ●		\$3.50	\$26.80	-	

## ✓ Instrument Cassettes

### CODES & Colours

Each Per 10 Box My Order

<input type="checkbox"/>	540 x 180 x 50 mm Perforated - TRAY ONLY	IC54X18TRGR	●	\$65.00	\$500.00	5	
<input type="checkbox"/>	540 x 180 x 50 mm Perforated - LID ONLY	IC54X18LIDGR	●	\$21.00	\$160.00	5	
<input type="checkbox"/>	Silicone Racks ONLY to fit 540 x 180 x 50 mm Tray	IC54X18RAKWH	○	\$3.00	\$214.00 per	100	
<input type="checkbox"/>	540 x 160 x 40 mm Perforated - TRAY ONLY	IC54X16TRGR	●	\$52.00	\$390.00	5	
<input type="checkbox"/>	540 x 160 x 40 mm Perforated - LID ONLY	IC54X16LIDGR	●	\$29.00	\$220.00	5	
<input type="checkbox"/>	300 x 205 x 30 mm Perforated - TRAY ONLY	IC30X20TRGR	●	\$18.20	\$140.00	10	
<input type="checkbox"/>	300 x 205 x 30 mm Perforated - LID ONLY	IC30X20LIDGR	●	\$14.30	\$110.00	10	
<input type="checkbox"/>	Silicone Racks ONLY to fit 300 x 205 x 30 mm Tray	IC30X20RAKWH	○	\$2.58	\$160.00 per	100	
<input type="checkbox"/>	180 x 90 x 20 mm Perforated - TRAY, LID & RACKS	IC18X9GR	●	\$33.00	\$250.00	10	
<input type="checkbox"/>	Silicone Racks ONLY to fit 180 x 90 x 20 mm Tray	IC18X9RAKWH	○	\$2.14	\$150.00 per	100	
<input type="checkbox"/>	90 x 90 x 20 mm Perforated - TRAY & LID Set	IC09X09GR	●	\$14.50	\$96.00	10	

## ✓ Dental Tray - Perforated w/ Compartments

### CODE & Colour

Each Per 10 BOX My Order

<input type="checkbox"/>	300 x 205 x 20 mm Perforated 5 Compartmt. TRAY	TRPD20X30GR	●	\$16.00	\$122.00	10	
--------------------------	--	-------------	---	---------	----------	----	--

Prices exclude GST and freight. Include CODES to specify colour. Fill in pages and send scans or photographs to order, or email us: [info@douglasbean.com.au](mailto:info@douglasbean.com.au) or call on (03) 9801 4400 or 1800 338 212 for orders & enquiries. You now can also request quotes online at [douglasbean.com.au](http://douglasbean.com.au)



# Forceps

- Reusable • Suitable for Autoclaving
- Large Forceps sold in boxes of 20;
- Small Forceps sold in packs of 100 or boxes of 1,000

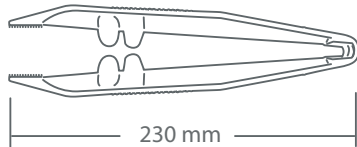

Large FORCEPS  
available in Mushroom ●

FORC230MU

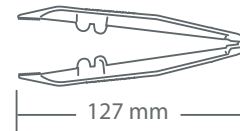

Small FORCEPS  
available in Yellow ● and Mushroom ●

FORC127YE

FORC127MU

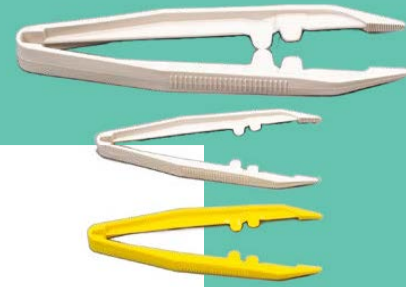

Size  
Colours  
Codes

✓ FORCEPS	Colour & CODES	PRICES	Box Qty.	My Order Qty
<input type="checkbox"/> 230 mm Forceps	<span style="color: #8B4513;">●</span> Mushroom only <b>FORC230MU</b>	\$4.00 ea    \$31.00 per 10		<input type="text"/> <span style="color: #8B4513;">●</span>
<input type="checkbox"/> 127 mm Forceps	<span style="color: #8B4513;">●</span> Mushroom <b>FORC127MU</b>	\$46.80 / 100    \$312.00 per 1000    \$2,960.00 per 10,000		<input type="text"/> <span style="color: #8B4513;">●</span>
<input type="checkbox"/> 127 mm Forceps	<span style="color: #FFD700;">●</span> Yellow <b>FORC127YE</b>	\$46.80 / 100    \$312.00 per 1000    \$2,960.00 per 10,000		<input type="text"/> <span style="color: #FFD700;">●</span>

# Identity Pads

These reusable Identity Pads are useful for labelling packs, bundles and instruments during washing and autoclaving. They can be attached with plastic zip ties and come in 5 different colours.

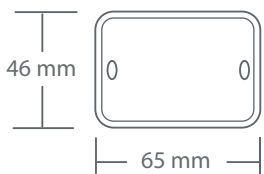

● Blue    ● Pastel Green    ● Mushroom    ● Shell Pink    ● Yellow

IDPAD6X5BL    IDPAD6X5GR    IDPAD6X5MU    IDPAD6X5SP    IDPAD6X5YE

Size  
Colours  
Codes

✓ IDENTITY PADS	COLOURS & CODES	Per 20	Per 100	Per 1000	Box Qty.	My Order Qty.
<input type="checkbox"/> Identity Pad, 65 x 46 mm	<span style="color: #FFD700;">●</span> Yellow <b>IDPAD6X5YE</b>	\$35.00	\$109.00	\$981.00		<input type="text"/> <span style="color: #FFD700;">●</span>
<input type="checkbox"/> Identity Pad, 65 x 46 mm	<span style="color: #4169E1;">●</span> Blue <b>IDPAD6X5BL</b>	\$35.00	\$109.00	\$981.00		<input type="text"/> <span style="color: #4169E1;">●</span>
<input type="checkbox"/> Identity Pad, 65 x 46 mm	<span style="color: #8B4513;">●</span> Mushroom <b>IDPAD6X5MU</b>	\$35.00	\$109.00	\$981.00		<input type="text"/> <span style="color: #8B4513;">●</span>
<input type="checkbox"/> Identity Pad, 65 x 46 mm	<span style="color: #90EE90;">●</span> Pastel Green <b>IDPAD6X5GR</b>	\$35.00	\$109.00	\$981.00		<input type="text"/> <span style="color: #90EE90;">●</span>
<input type="checkbox"/> Identity Pad, 65 x 46 mm	<span style="color: #FFB6C1;">●</span> Shell Pink <b>IDPAD6X5SP</b>	\$35.00	\$109.00	\$981.00		<input type="text"/> <span style="color: #FFB6C1;">●</span>



# Medical Measures

## Size Autoplas 40 ml Conical Measure

Graduated Measure is reusable and autoclavable.



Size

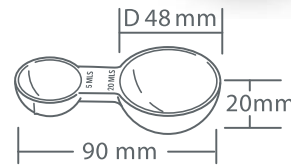
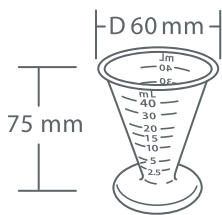

## Autoplas 5 ml/20ml Spoon Measure

Spoon Measure is reusable and autoclavable.

Conical Measure available in Natural only.

Spoon available in White only

Codes

MMCON040NA

MMSPNWH

## Size Autoplas 60 ml Tumbler Medicine Measure

Graduated Measure is reusable and autoclavable.

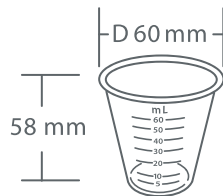

Autoplas 60 ml  
Medicine Measure  
Tumbler

Tumbler available in Natural only

Code

MMTUMB060NA

## MEDICAL MEASURES Price List / Order Form

✓ MEDICAL MEASURES	Colour	Item Code	1-9 items	10-99 items	100 - 999	per 1,000+	Carton Qty.	My Order Qty.
<input type="checkbox"/> 40 ml Conical Measure	Natural <input type="radio"/>	MMCON040NA	Coming Soon - contact us for details on these products info@douglasbean.com.au				<input type="checkbox"/> 100	<input type="checkbox"/>
<input type="checkbox"/> 60 ml Tumbler Measure	Natural <input type="radio"/>	MMTUMB060NA					<input type="checkbox"/> 100	<input type="checkbox"/>
<input type="checkbox"/> 5/20 ml Spoon Measure	White <input type="radio"/>	MMSPNWH					<input type="checkbox"/> 20	<input type="checkbox"/>



Company founder Douglas Bean and family c.1981



DBA Company Directors Richard and Nick Bean

For more than fifty years Douglas Bean Australia has provided durable, reliable Medical products, all designed and manufactured in Australia. We continually strive to reduce our environmental impact. Our Melbourne warehouse is now fully solar and battery powered. Our products are all reusable, often last for many years, and every one is recyclable:

Design, Manufacture and Distribution by  
Douglas Bean Australia Pty. Ltd. A.C.N. 005 443 863  
84 Lewis Road, Wantirna South, Victoria 3152 Australia  
[www.douglasbean.com.au](http://www.douglasbean.com.au) email: [info@douglasbean.com.au](mailto:info@douglasbean.com.au)  
Telephone: **03 9801 4400** or **1800 338 212**

Douglas Bean products are manufactured under a Quality Management system certified as complying with ISO 9001 standard.



PP



Global-Mark.com.au®



**Douglas Bean**  
Australia



MEDICAL

CATERING

LABORATORY

[Back to Contents Page](#)